

FQCW 266-50

Diode Pumped Continuous Wave Solid State Laser

- 266 nm
- Continuous Wave
- Single Frequency
- Low Intensity Noise
- $M^2 < 1.3$, TEM₀₀
- Up to 50 mW
- Conduction Cooled
- Patented Design (*)



lithography · inspection · spectroscopy · analytics

Optical Data	Wavelength	266 ± 1 nm
	Nominal Output Power	50 ± 2 mW
	Output Power Adjustability	5 – 55 mW
	Linewidth	< 300 kHz
	Coherence Length	> 1000 m
	Beam Propagation Factor M ²	< 1.3, TEM ₀₀
	Polarisation orientation and purity	vertical, > 100:1
	Beam Diameter	0.6 ± 0.1 mm
	Beam Divergence	< 0.8 mrad
	Beam Pointing Stability ⁽²⁾	< 3 µrad/K, < 3 µrad/h
	Static Alignment Tolerance ⁽²⁾	lateral ± 0.25 mm, angular ± 2.5 mrad
	Power Stability ⁽¹⁾	< 1 %rms
	Noise (100 kHz – 10 MHz)	< 1 %rms
Electrical Data	Power Consumption Mean (Max)	< 100 W (160 W)
	Line Voltage for external power supply	85 - 264 V AC (47-63 Hz)
	Communication Interfaces	USB / RS232
	Safety Features	key switch, interlock
Miscellaneous	Warm-up Time (cold starting)	< 15 min
	Operating Temperature (laser head)	20 - 35 °C non-condensing
	Laser Head Dimensions	91 x 270 x 379 mm ³ (H x W x L)
	Control Unit Dimensions (w/o connectors)	42 x 165 x 164 mm ³ (H x W x L)
	Laser Head Weight	14.7 kg
	Control Unit Weight	1.0 kg

Notes

1. After 30 minutes warm-up in the temperature range 20 - 35 °C, temperature change < 1 K/h.
2. Position and angle of static alignment tolerances are specified with regard to laser beam exit.
3. The exit window is equipped with the Manual Window Shifter (MWS) in case of external photo contamination. This laser system is equipped with the Automatic Crystal Shifter (ACS).

(*) Protected by patents: DE102022104383B3, DE102010064382B4, US9429814B2

Dimensions

Laser Head:

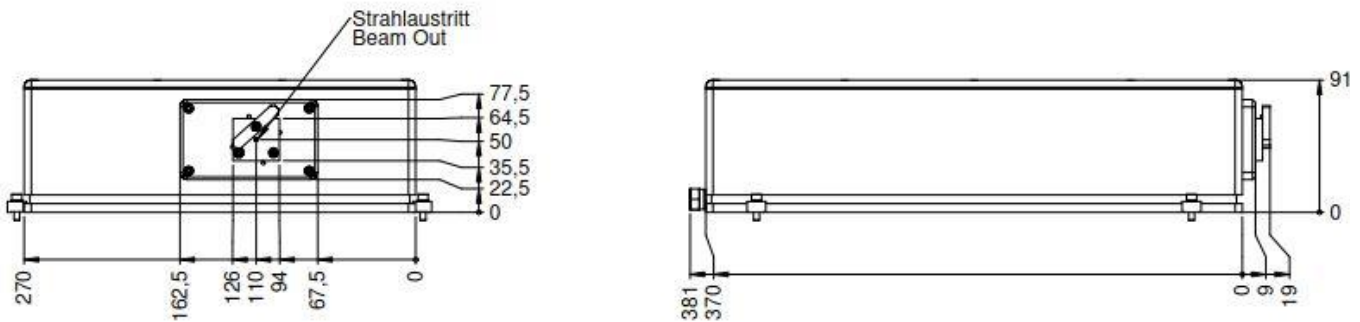

Control Unit:

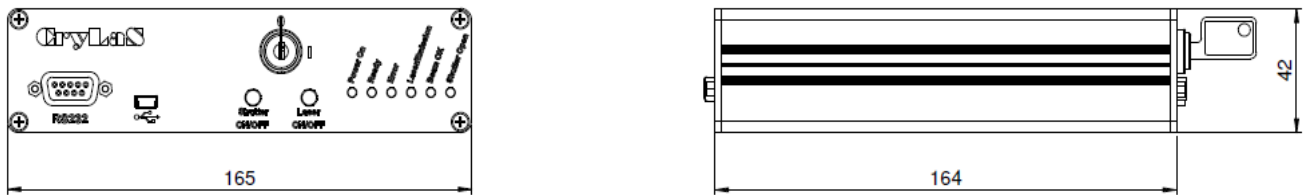

All dimensions in mm

Laser Safety Labels

FQCW266 laser sources are class 4 / IV lasers according to IEC 60825-1

